

HIGH PERFORMANCE  
GERMAN MADE  
OSRAM LEDS

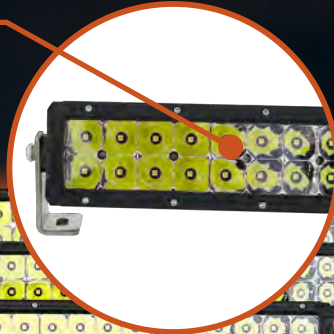

SUPERIOR  
ALUMINIUM  
HEAT-SINK

# SABRE LASER

COMBINATION BEAM LASER LIGHT BARS



DOUBLE ROW  
STYLE



INTENSE DISTANCE  
LASER BEAM



STRONG ADJUSTABLE BRACKET

COMBINATION BEAM  
LASER + WIDE FLOOD



HEAVY DUTY  
STAINLESS STEEL  
BRACKETS



SINGLE ROW  
STYLE



MULTIPLE SIZES TO  
FIT MOST VEHICLES

# SABRE SERIES

SABRE LASER LIGHT BAR RANGE



**3 YEAR WARRANTY**  
\*ON LUMINAIRE



**IMPACT RESISTANT**



**LONG RANGE BEAM**



**IP67 WATER RESISTANCE**



**COMBINATION LASER + LED**

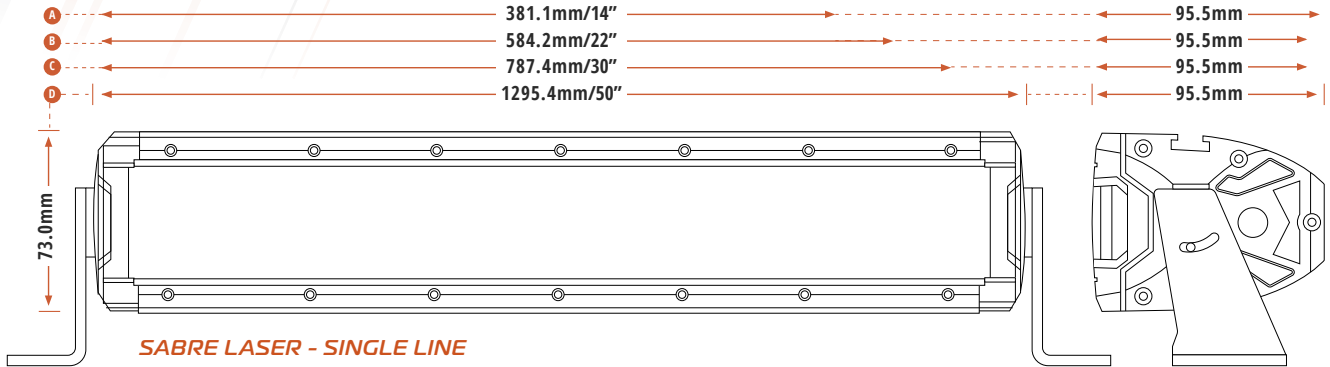

EVSLxxxLED (50")

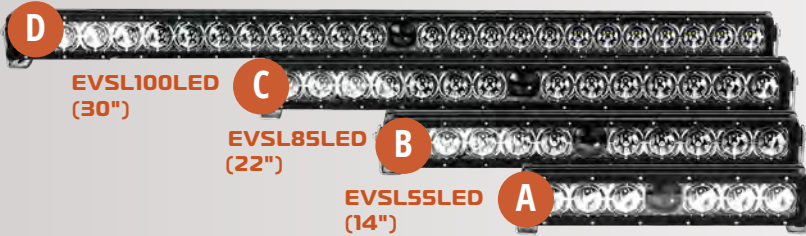

**SABRE LASER SINGLE LINE**

EVSLD200LED (50")

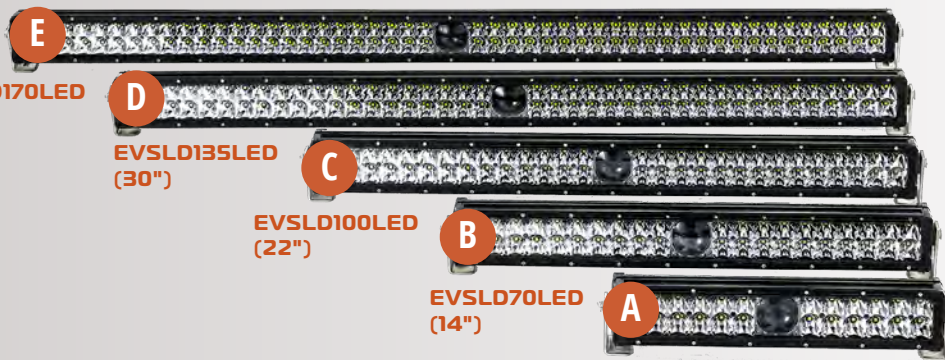

**SABRE LASER DUAL LINE**

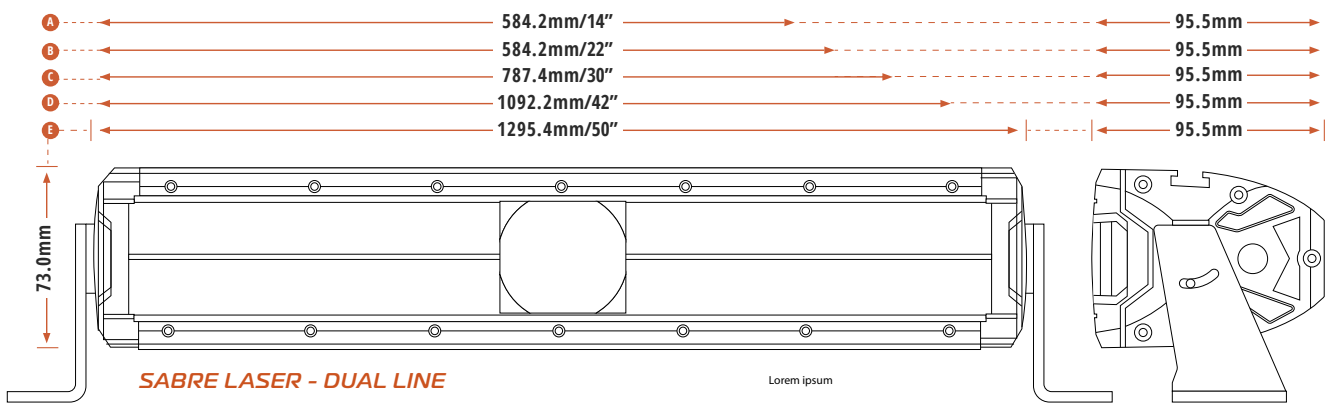



# SABRE SERIES

SABRE LASER LIGHT BAR RANGE



**3 YEAR WARRANTY**  
\*ON LUMINAIRE



**IMPACT RESISTANT**



**LONG RANGE BEAM**



**IP67 WATER RESISTANCE**



**COMBINATION LASER + LED**



**EVSL55LED | 14"**



**EVSL85LED | 22"**

**SPECIFICATIONS**

WATTAGE  
LIGHT SOURCE  
LIGHT OUTPUT  
VOLTAGE  
OPERATING TEMP.  
COLOUR TEMP.  
IP RATING  
CONNECTOR TYPE  
HOUSING  
LENS CONSTRUCTION  
BRACKET  
LIFESPAN  
NET WEIGHT  
MOUNTING SUITABLE  
BEAM  
WARRANTY

**SINGLE 55W LASER LIGHT BAR**

55 WATT  
OSRAM P9 LEDS + LASER  
4,500 LUMEN  
10V-30V DC  
-40°C TO +60°C  
6000K  
IP67  
DEUTSCH CONNECTOR  
DIECAST ALUMINUM ALLOY  
POLYCARBONATE  
STAINLESS STEEL  
50,000 HOURS  
2.46 KG  
UPRIGHT  
LASER + FLOOD

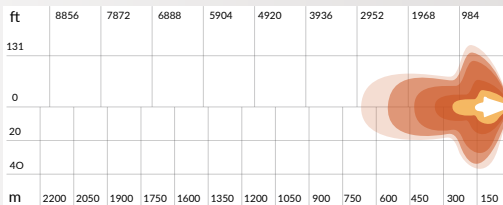

**BEAM** LASER + FLOOD  
**CODES** EVSL55LED

**SINGLE 85W LASER LIGHT BAR**

85 WATT  
OSRAM P9 LEDS + LASER  
7,250 LUMEN  
10V-30V DC  
-40°C TO +60°C  
6000K  
IP67  
DEUTSCH CONNECTOR  
DIECAST ALUMINUM ALLOY  
POLYCARBONATE  
STAINLESS STEEL  
50,000 HOURS  
3.25 KG  
UPRIGHT  
LASER + FLOOD

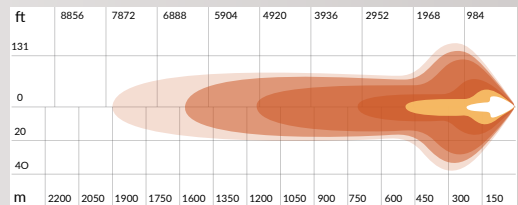

**BEAM** LASER + FLOOD  
**CODES** EVSL85LED

# SABRE SERIES

SABRE LASER LIGHT BAR RANGE



**SPECIFICATIONS**

- WATTAGE
- LIGHT SOURCE
- LIGHT OUTPUT
- VOLTAGE
- OPERATING TEMP.
- COLOUR TEMP.
- IP RATING
- CONNECTOR TYPE
- HOUSING
- LENS CONSTRUCTION
- BRACKET
- LIFESPAN
- NET WEIGHT
- MOUNTING SUITABLE
- BEAM
- WARRANTY

**SINGLE 110W LASER LIGHT BAR**

**110 WATT**  
**OSRAM P9 LEDS + LASER**  
**10,000 LUMEN**  
**10V-30V DC**  
**-40°C TO +60°C**  
**6000K**  
**IP67**  
**DEUTSCH CONNECTOR**  
**DIECAST ALUMINUM ALLOY**  
**POLYCARBONATE**  
**STAINLESS STEEL**  
**50,000 HOURS**  
**4.0 KG**  
**UPRIGHT**  
**LASER + FLOOD**

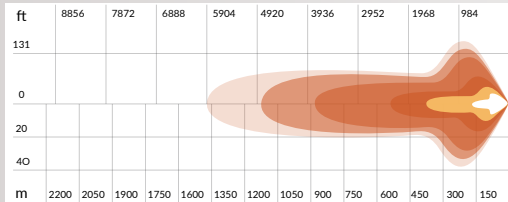

**BEAM** LASER + FLOOD  
**CODE** EVSL110LED

**SINGLE 135W LASER LIGHT BAR**

**200 WATT**  
**OSRAM P9 LEDS + LASER**  
**16,700 LUMEN**  
**10V-30V DC**  
**-40°C TO +60°C**  
**6000K**  
**IP67**  
**DEUTSCH CONNECTOR**  
**DIECAST ALUMINUM ALLOYAT-SINK**  
**POLYCARBONATE**  
**STAINLESS STEEL**  
**50,000 HOURS**  
**6.0 KG**  
**UPRIGHT**  
**LASER + FLOOD**

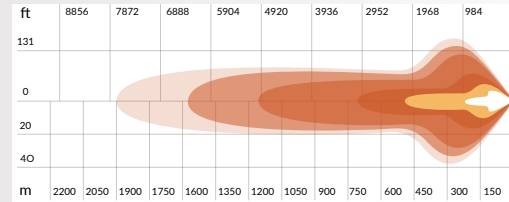

**BEAM** LASER + FLOOD  
**CODE** EVSL200LED

# SABRE SERIES

SABRE LASER LIGHT BAR RANGE ~ DUAL LINE



**3 YEAR WARRANTY**  
\*ON LUMINAIRE



**IMPACT RESISTANT**



**LONG RANGE BEAM**



**IP67 WATER RESISTANCE**



**COMBINATION LASER + LED**



## SPECIFICATIONS

**WATTAGE**  
**LIGHT SOURCE**  
**LIGHT OUTPUT**  
**VOLTAGE**  
**OPERATING TEMP.**  
**COLOUR TEMP.**  
**IP RATING**  
**CONNECTOR TYPE**  
**HOUSING**  
**LENS CONSTRUCTION**  
**BRACKET**  
**LIFESPAN**  
**NET WEIGHT**  
**MOUNTING SUITABLE**  
**WARRANTY**

### DUAL 70W LASER LIGHT BAR

**70 WATT**  
**OSRAM P9 LEDS + LASER**  
**8,000 LUMEN**  
**10V-30V DC**  
**-40°C TO +60°C**  
**6000K**  
**IP67**  
**DEUTSCH CONNECTOR**  
**DIECAST ALUMINUM ALLOY**  
**POLYCARBONATE**  
**STAINLESS STEEL**  
**50,000 HOURS**  
**2.13 KG**  
**UPRIGHT**  
**3 YEARS**

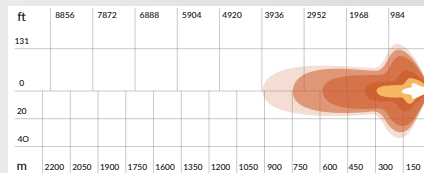

**BEAM**  
**CODES**

**LASER + FLOOD**  
**EVSLD70LED**

### DUAL 100W LASER LIGHT BAR

**100 WATT**  
**OSRAM P9 LEDS + LASER**  
**12,900 LUMEN**  
**10V-30V DC**  
**-40°C TO +60°C**  
**6000K**  
**IP67**  
**DEUTSCH CONNECTOR**  
**DIECAST ALUMINUM ALLOY**  
**POLYCARBONATE**  
**STAINLESS STEEL**  
**50,000 HOURS**  
**3.2 KG**  
**UPRIGHT**  
**3 YEARS**

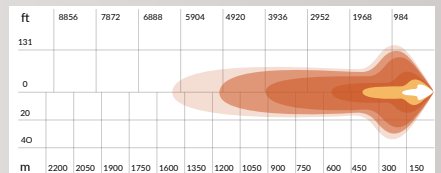

**LASER + FLOOD**  
**EVSLD100LED**

# SABRE SERIES

SABRE LASER LIGHT BAR RANGE ~ DUAL LINE



**DUAL 135W LASER LIGHT BAR**

- 135 WATT
- OSRAM P9 LEDS + LASER
- 20,000 LUMEN
- 10V-30V DC
- 40°C TO +60°C
- 6000K
- IP67
- DEUTSCH CONNECTOR
- DIECAST ALUMINUM ALLOY
- POLYCARBONATE
- STAINLESS STEEL
- 50,000 HOURS
- 4.0 KG
- UPRIGHT
- 3 YEARS

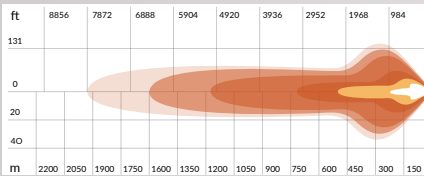

**LASER + FLOOD**  
**EVSLD135LED**

**DUAL 170W LASER LIGHT BAR**

- 170 WATT
- OSRAM P9 LEDS + LASER
- 23,000 LUMEN
- 10V-30V DC
- 40°C TO +60°C
- 6000K
- IP67
- DEUTSCH CONNECTOR
- DIECAST ALUMINUM ALLOY
- POLYCARBONATE
- STAINLESS STEEL
- 50,000 HOURS
- 5.15 KG
- UPRIGHT
- 3 YEARS

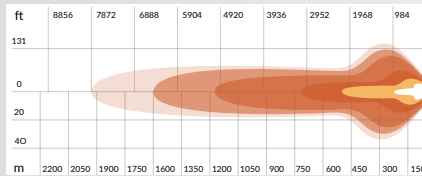

**LASER + FLOOD**  
**EVSLD170LED**

**DUAL 200W LASER LIGHT BAR**

- 200 WATT
- OSRAM P9 LEDS + LASER
- 29,000 LUMEN
- 10V-30V DC
- 40°C TO +60°C
- 6000K
- IP67
- DEUTSCH CONNECTOR
- DIECAST ALUMINUM ALLOY
- POLYCARBONATE
- STAINLESS STEEL
- 50,000 HOURS
- 6.0 KG
- UPRIGHT
- 3 YEARS

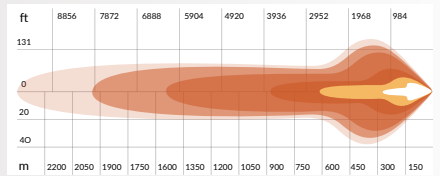

**LASER + FLOOD**  
**EVSLD200LED**